

TS402-1.1-SC-T42-SM

HIGH EFFICIENCY TOILET FLUSH VALVE
(1.1 gpf / 4.6 Lpf)

TruSABER

Description

Exposed chrome plated flush valve for 1-1/2" top spud floor mounted or wall hung water closets with side mounted sensor activated actuator ("SideArm")

Flush Cycle

1.1 gpf / 4.6 Lpf High Efficiency

Specification

- SideArm (side mounted sensor actuator)
- Regulating screw for "True-in-the-Field" water conservation.
- Mashaerator self-cleaning bypass diaphragm
- 1" vandle proof TruStop ball valve designed angle control stop with TruChek.
- Sweat adapter kit
- Renewable main valve seat
- ADA compliant metal "Rubberflex" oscillating handle.
- Slip-Joint adjustable tailpiece
- 1.5" x 9" vacuum breaker flush connection
- Wall flange, spud nut and spud flange for 1.5" top spud
- All rubber parts molded of chloramine resistant rubber

Variations

- AM - Antimicrobial Coated Handle
- G - Bumper on Control Stop for Seat
- SH - SmartHandle Dual-Flush with Antimicrobial Coating
- T5 - Non-Hold-Open Feature
- T6 - Wall flange with allen set screw
- T36 - Solid ring wall support for flush connection
- T46 - Split ring wall support for flush connection
- VPS - Vandal Proof Control Stop with Key
- Logo - Customized Cover Cap w/ Logo

Valve is certified to be in compliance to the applicable sections of ASSE 1037 and ANSI/ASME 112.19.2

WaterSense Listed and compliant when paired with a WaterSense compliant fixture.

* Recommended for both hard water and highly chlorinated water conditions.

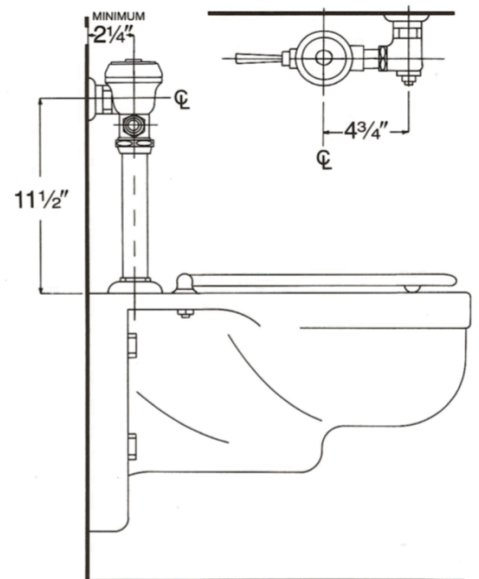

ASSE 1037

