

U451-0.5-SM

HIGH EFFICIENCY TOILET FLUSH VALVE
(0.5 gpf / 1.9 Lpf)

ULTRA w/ SideArm

Description

Exposed chrome plated flush valve diaphragm operated for 3/4" top spud urinals with side mounted sensor actuator.

Flush Cycle

0.5 gpf / 1.9 Lpf High Efficiency

Specification

- SideArm (Side Mounted Sensor Actuator)
 - Infrared Sensor with user indicator light
 - True Mechanical Override Button
 - 6 volts DC low voltage four "C" batteries
 - 8 second arming delay to prevent unintentional flushes
- Regulating screw for "True-in-the-Field" water conservation.
- ADA compliant metal "Rubberflex" oscillating handle.
- Renewable main valve seat.
- 1" vandle resistant capped screwdriver angle stop with back-check.
- Sweat adapter kit.
- SlipFit adjustable tailpiece.
- 3/4" x 9" vacuum breaker flush connection.
- Wall flange, spud nut and spud flange for 3/4" top spud.
- All rubber parts molded of chloramine resistant rubber.

Variations

- G – Bumper on angle stop (for seat without cover)
- GJ – Ground Joint Tailpiece
- T5 – Non-Hold-Open Feature
- T6 – Wall flange with allen set screw
- T36 – Solid ring wall support for flush connection
- T46 – Split ring wall support for flush connection
- TS - TruStop - Ball Valve Designed Control Stop
- VPS – Vandal Proof Control Stop with Key

Valve is certified to be in compliance to the applicable sections of ASSE 1037 and ANSI/ASME 112.19.2
WaterSense Listed and compliant when paired with a WaterSense compliant fixture.

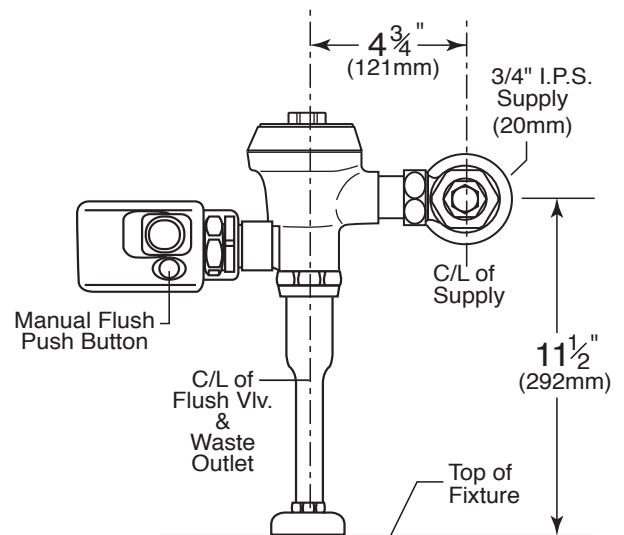

ASSE 1037

